



Product technical sheet

SOLO 0832



3 - 14 years



4 kids



17,6 m²

Material specification

- Powder galvanized and powder coated steel construction,
- Platforms made of durable anti-slip and waterproof HPL plate,
- Side panels made of durable HDPE plate, resistant to weather conditions
- Slides made of stainless steel with durable HDPE side panels,
- Stainless steel bars, ladders and handrails,
- Screws covered with plastic caps and/or stainless steel screws,
- Safe end caps on top of the structure made of rubber or polypropylene,



Physical development



sliding



climbing





1
number of slides



1
number of activity elements

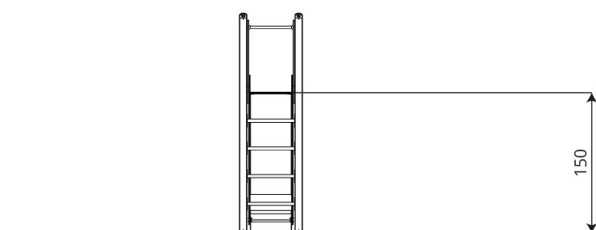
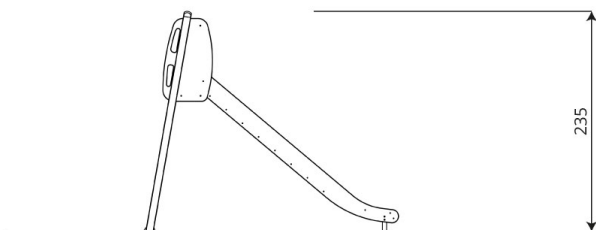
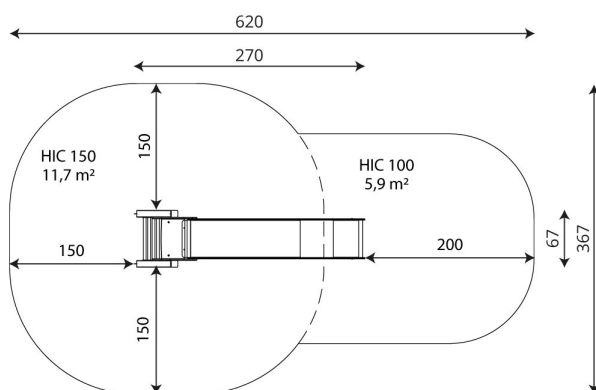

Product technical sheet

SOLO 0832

Product data

Length	270 cm
Width	67 cm
Total height	235 cm
Age group	3 - 14 years
Number of users	4 kids
Safety zone	17,6 m2
Free fall height	150 cm
The height of the platforms	150 cm
In accordance with norm EN	1176-1:2017
Weight of the heaviest part	40 kg
Dimensions of the largest part	262x52x15 cm
Availability of spare parts	YES
Installation time	2 h
Color options	

Data is subject to change without prior notice.

Additional information

- equipment intended for public playgrounds;
- equipment has a certificate issued by an accredited entity or a declaration of conformity;
- no sharp edges or chinks that would pose a danger of jimmieing the head, fingers or any other body parts;
- anchoring on flat surface, 80/70/60 cm deep;
- slide should not be installed southwards;
- render is for reference only, the actual appearance of the equipment and its color may vary;

Guarantee

30

30 year guarantee - Structural strength of steel and stainless steel components

15

15 year guarantee - Structural failure of steel and stainless steel, for dynamic equipment

10

10 year guarantee - Structural failure of high density polyethylene and high pressure laminates components

5

5 year guarantee - Corrosion of stainless steel and hot dip galvanized and powder coated components; against bark beetles and rot in case of wooden structural elements

Detailed information in the guarantee card



SOLO 0832

Surfaces according to EN 1176-1:2017

	Description (mm)	Layer thickness (cm)	Maximum fall heights (cm)
Turf/ top layer of soil (A,B,C)	-	-	≤100
bark (A,C)	Particle size from 20 to 80	30	≤200
		40	≤300
woodchips (A,C)	Particle size from 5 to 30	30	≤200
		40	≤300
sand or gravel (A,C)	Particle size from 0,25 to 8	30	≤200
		40	≤300
synthetic attested (A,B,C)	Tested according to EN 1177		150

Amount of safe surface corresponding with free fall height:

HIC 100	5,9 m ²
HIC 150	11,7 m ²

Data is subject to change without prior notice.

